

* minimum stroke is 0.75" (20mm)
** minimum space between numbers is 0.40" (10mm)

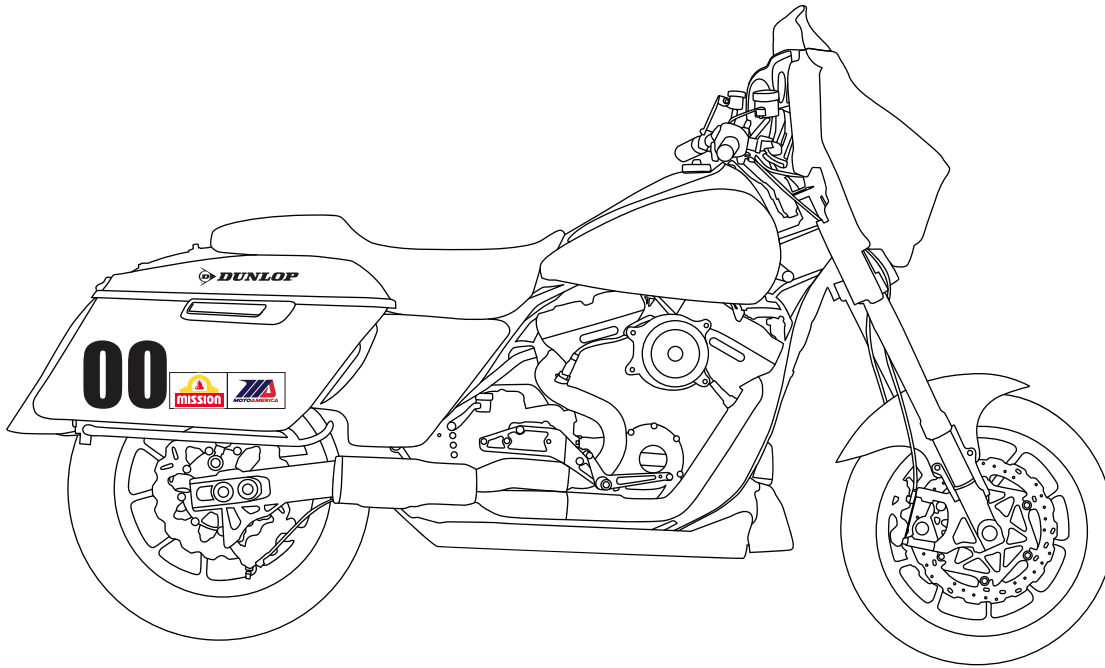

2.75" (70mm)
minimum

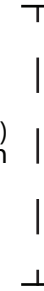

4.75" (120mm)
minimum

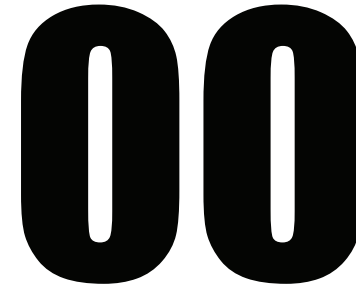

* minimum stroke is 0.75" (20mm)
** minimum space between numbers is 0.40" (10mm)

2.5" (63mm)
minimum



4" (101mm)



4" (101mm)

2.5" (63mm)
minimum

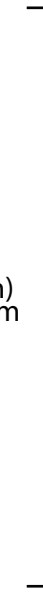

5.5" (140mm)
minimum



1.67" (42mm)

2.5" (63mm)
minimum



DUNLOP

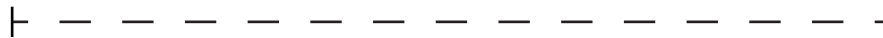

12" (305mm)

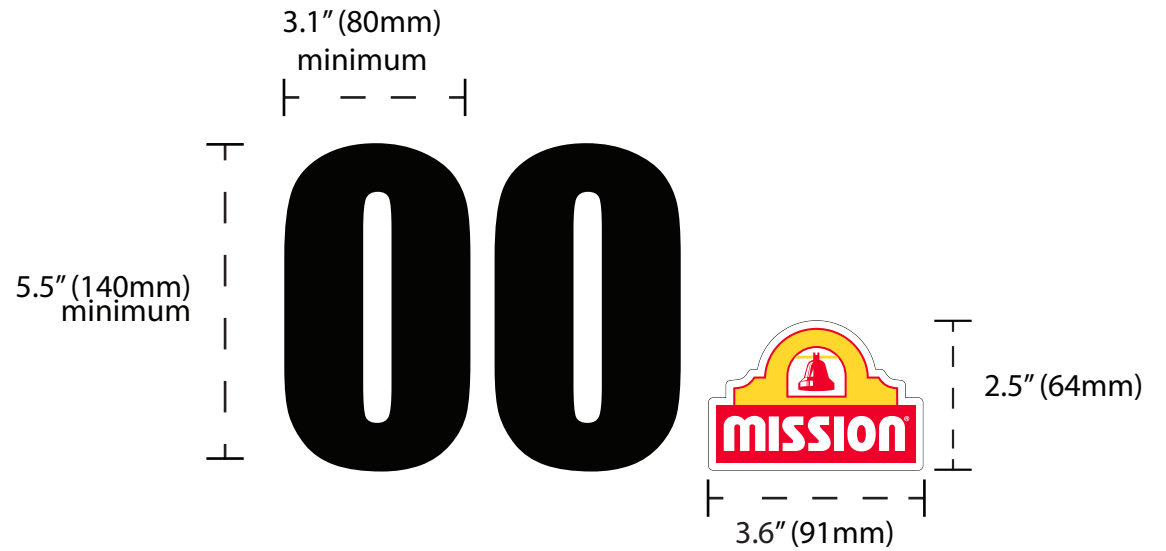
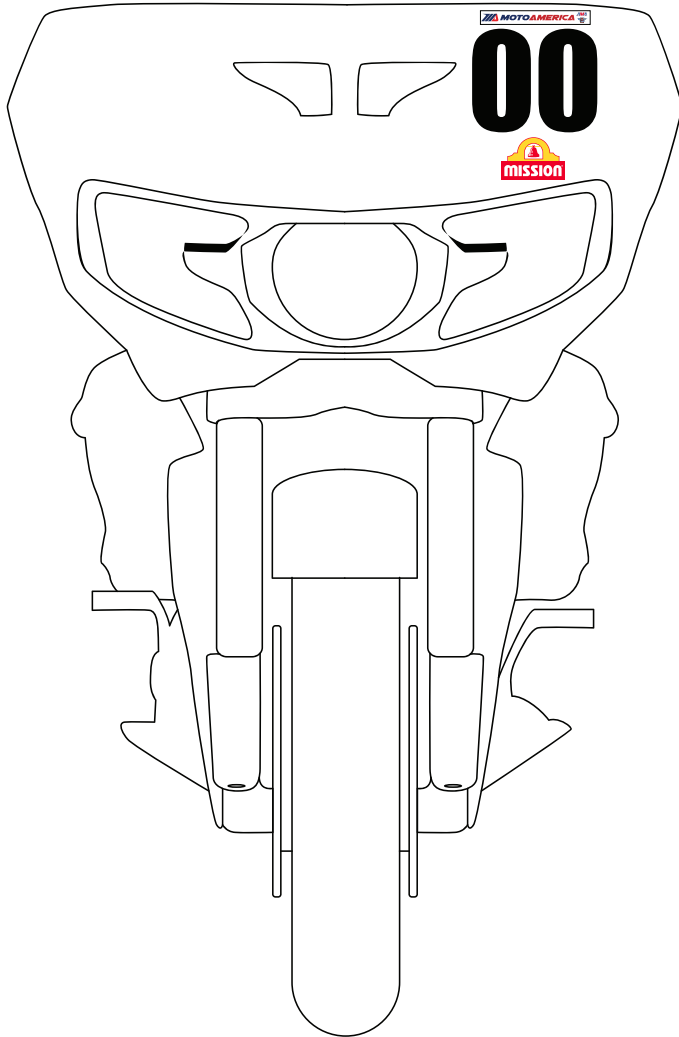

* minimum stroke is 0.75" (20mm)
** minimum space between numbers is 0.40" (10mm)

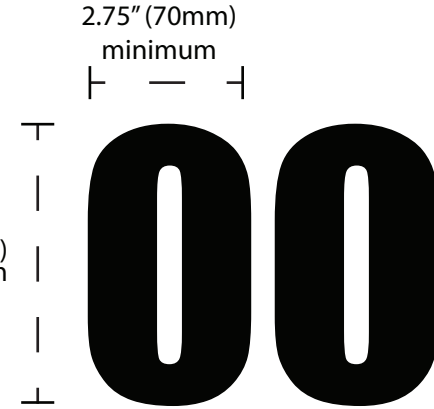
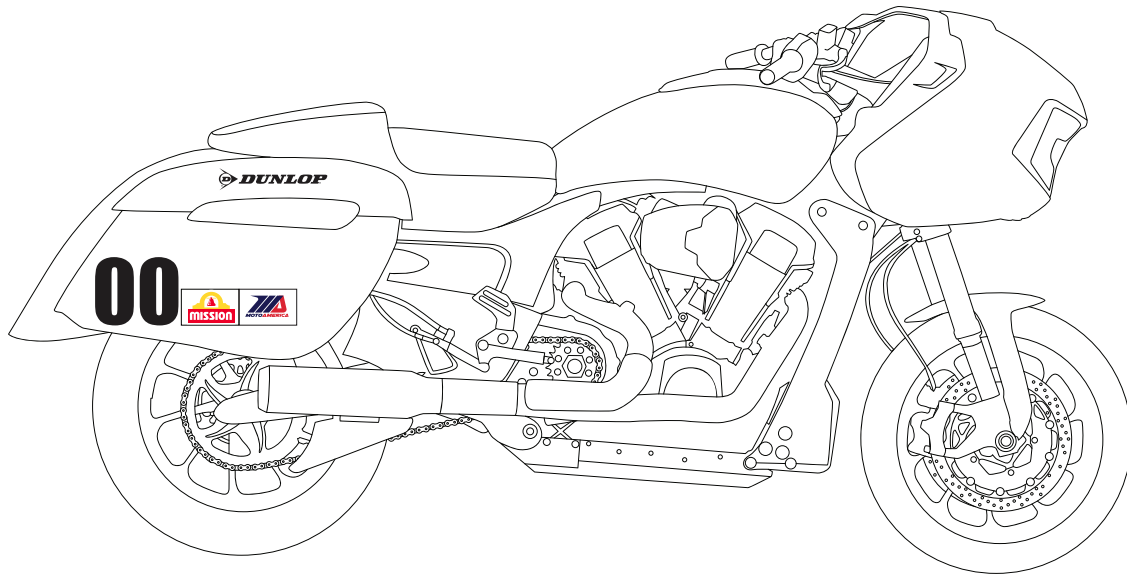

* minimum stroke is 0.75" (20mm)
 ** minimum space between numbers is 0.40" (10mm)

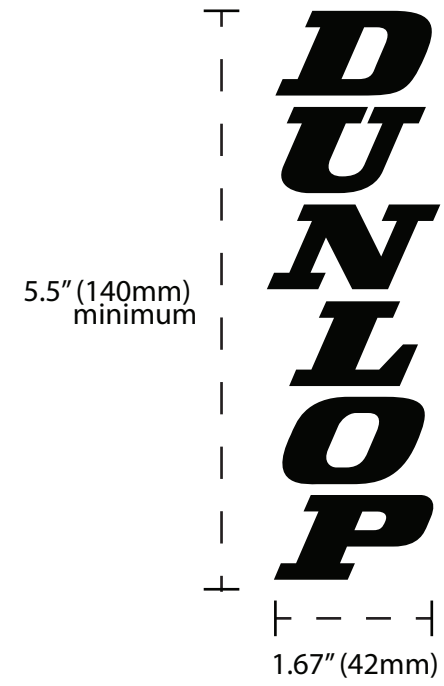
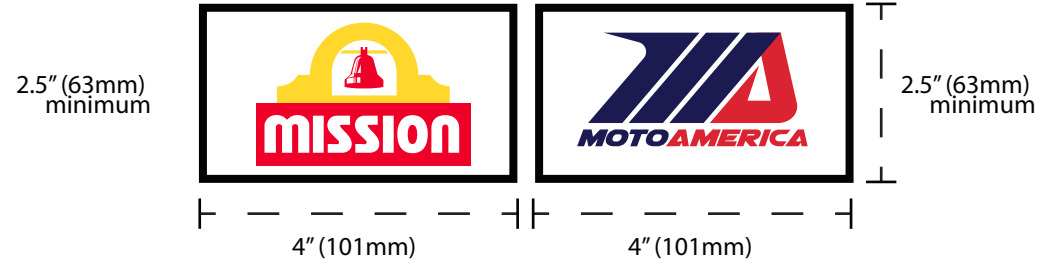



RIDER SUIT

SERIES PARTNER: 4.5" X 1.7"

MOTOAMERICA: 4" X 2"

DUNLOP (FRONT) : 4.82" X 1"

DUNLOP (REAR): 10" X 2.03"

AMA/FIMNA: 5" X 1.22"

*The series partner requirements will be released if required.
All teams must leave this space available.

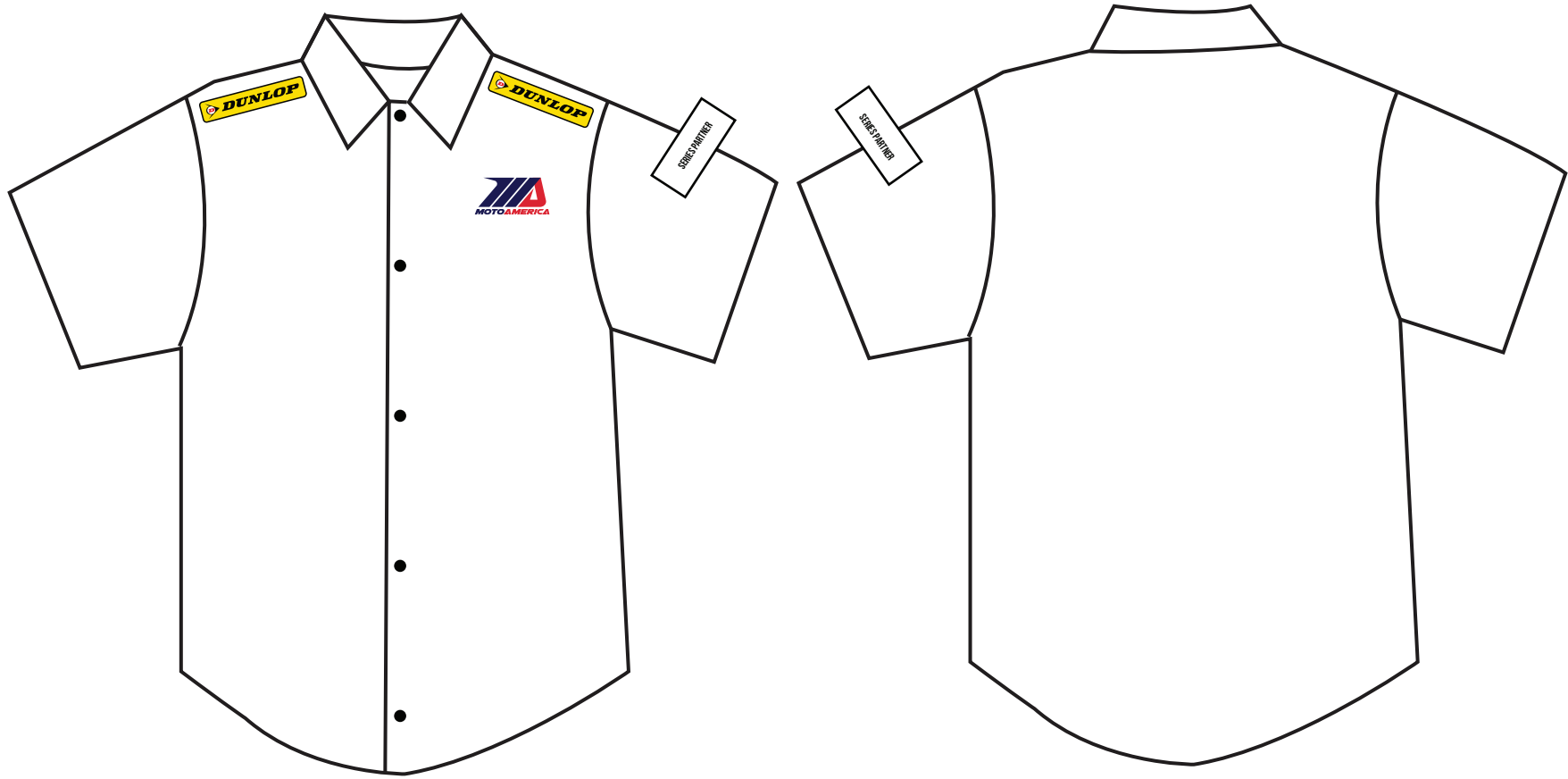

TEAM SHIRT

LOGOS ARE REQUIRED FOR COMPETITION

SERIES PARTNER*: 4.5"X1.75"

MOTOAMERICA SERIES LOGO 4"X 2"

DUNLOP (FRONT): 4.82"X1"

*The series partner requirements will be released if required.
All teams must leave this space available.